

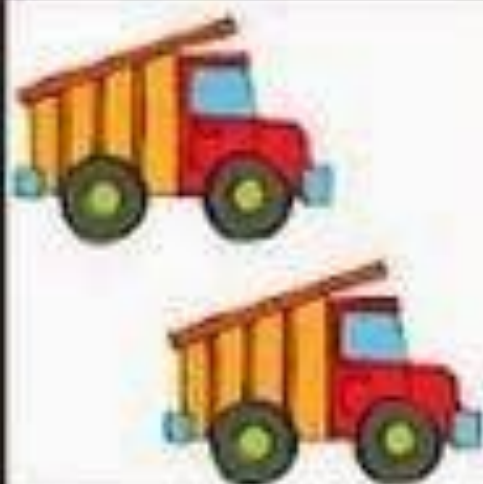



3	2	1
---	---	---



4	3	2
---	---	---

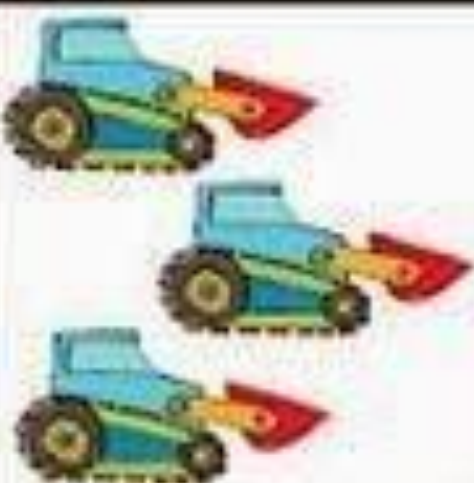

3	5	4
---	---	---

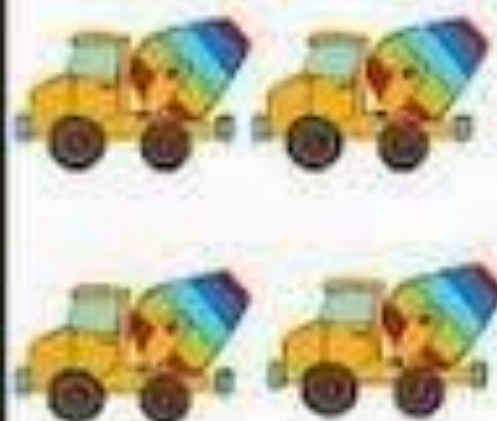

5	4	6
---	---	---

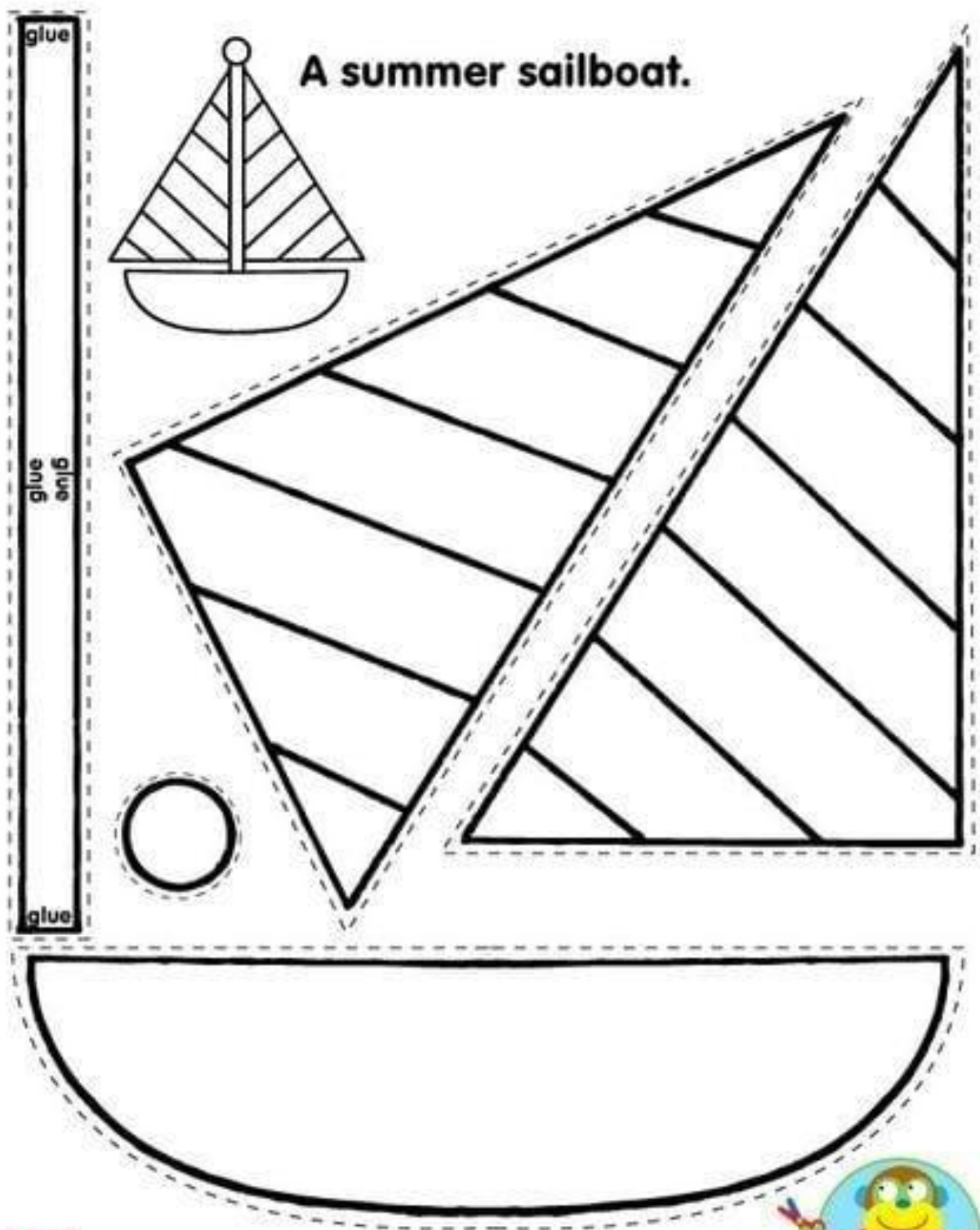

A summer sailboat.



alextoys.com Color, cut out and glue this boat together for summer fun!



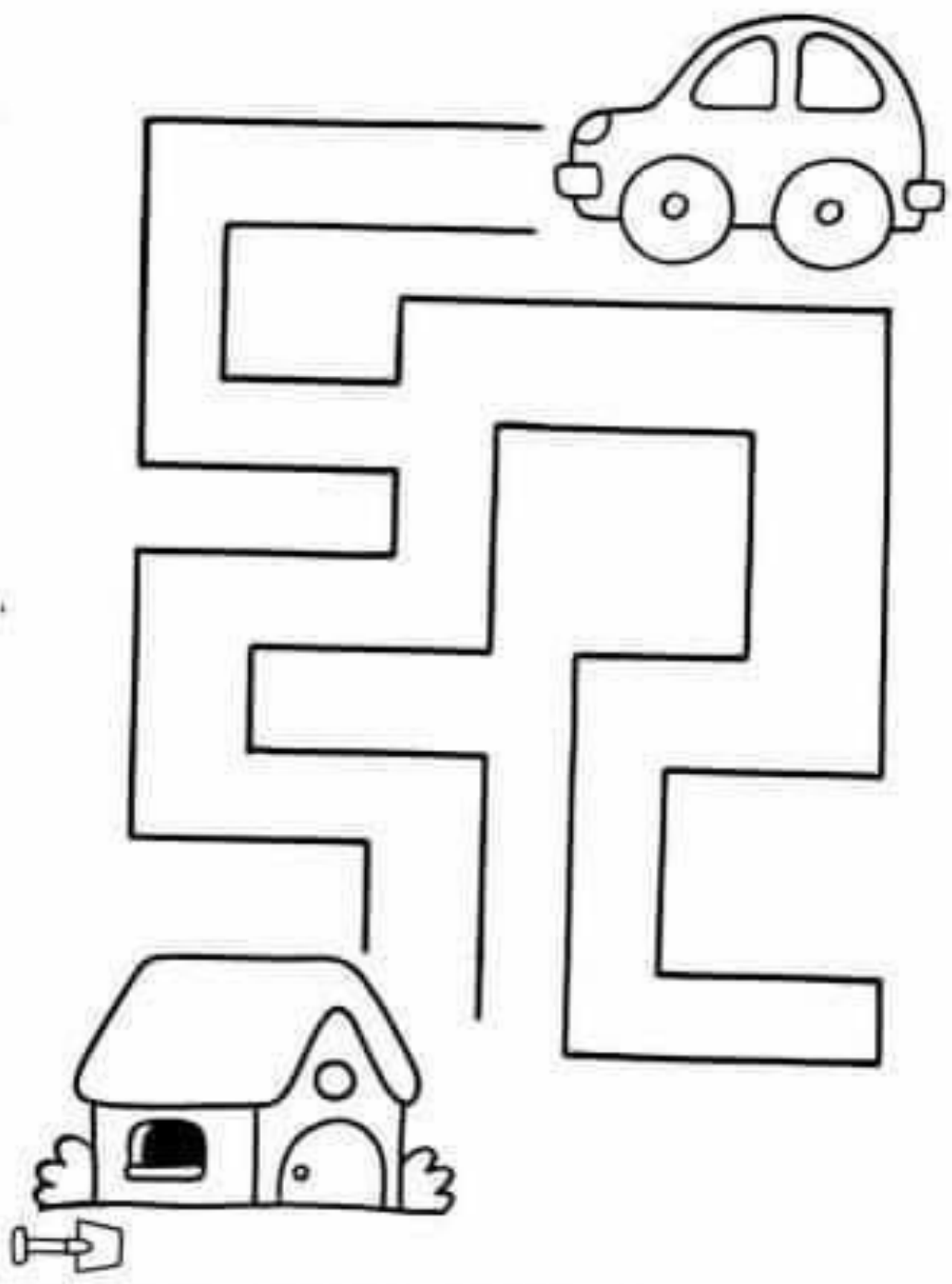

4



5



6



4

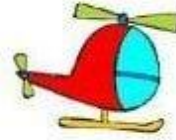
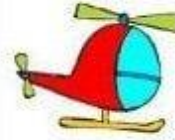

5



6

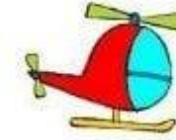
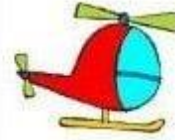

4



5



6

1

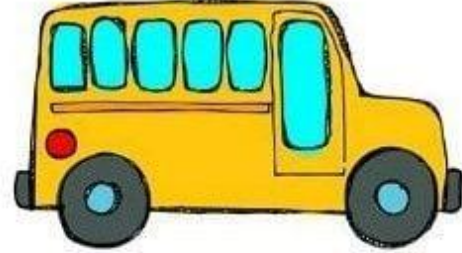

2

3

Graphics by KPIM Doodles <http://kpimdoodles.blogspot.com/>

Created by Mary Catherine of Fun-A-Day! <http://fun-a-day.com/>



FOTO 1



FOTO 2



FOTO 3



FOTO 4



FOTO 5



FOTO 6

Easy Paper Plate Car Craft for Kids

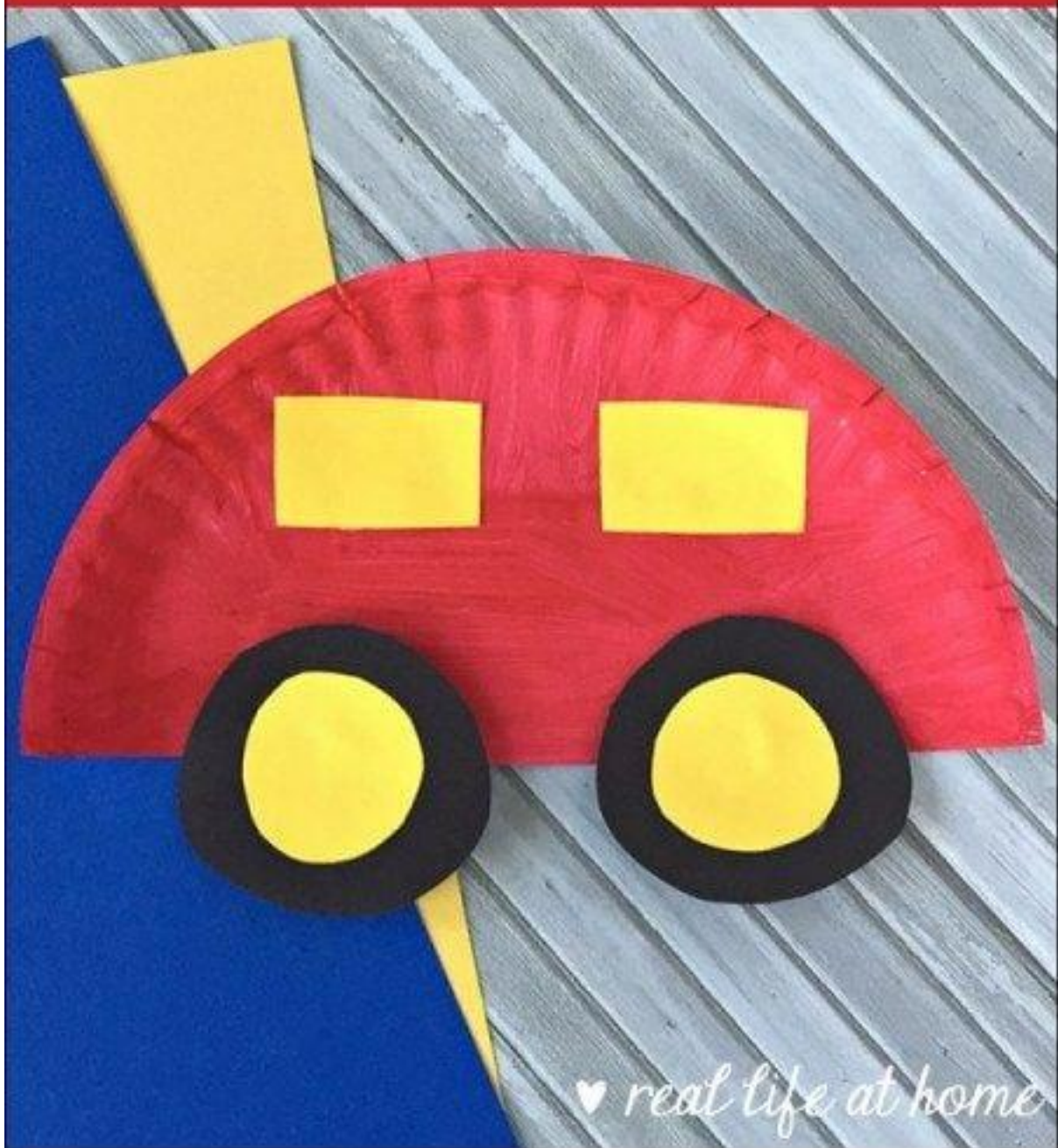

Colour the picture according to the chart

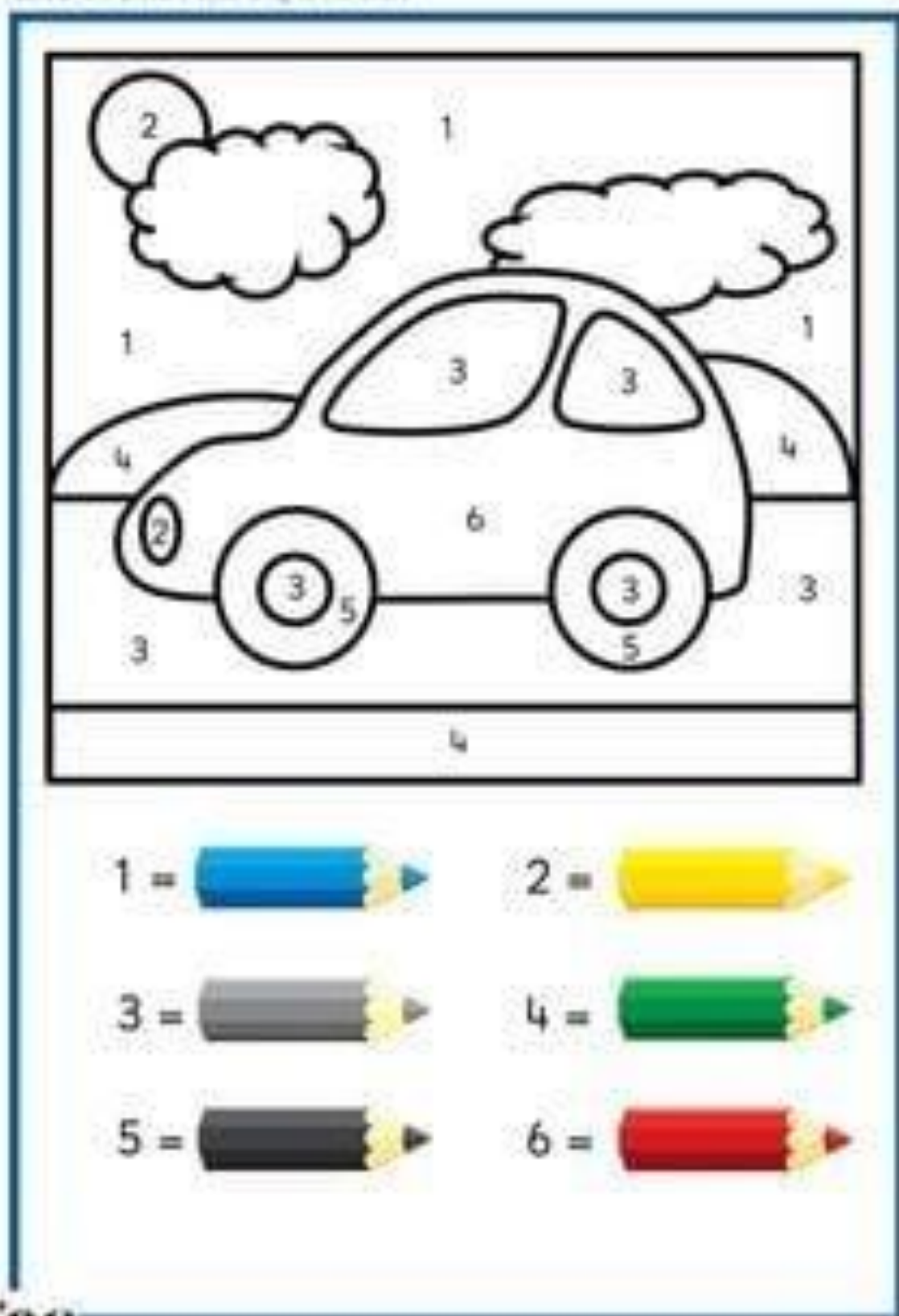

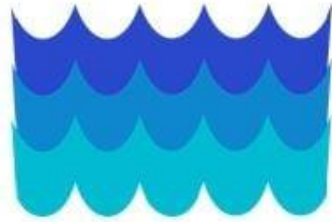
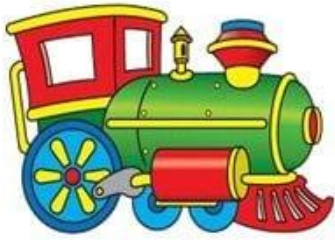

Správne prirad'

MALÉ AUTÍČKO A JEHO KAMARÁTI

BOLO RAZ MALÉ , KTORÉ BÝVALO V MESTE, KDE STÁLE SVIETILO .

MALO VEĽMI VEĽA KAMARÁTOV, KTORÍ MALI  AKO ON. SPOLU S  A .

SA MALÉ  VYBRALO NAVŠTÍVIŤ SVOJICH KAMARÁTOV V MESTE. VO VEDĽAJŠEJ ULICI BÝVALI , , , KTORÍ PREPRAVOVALI ĽUDÍ PO CELOM MESTE.

ZA MALÝM  NA KRAJI MESTA BÝVALI TRI , KTORÉ ŤAHALA VEĽKÁ .

S NIMI SA  VEĽMI RADO NAHÁŇALO. ZA MESTOM, KDE BOLO VEĽKÉ ,

KOTVILA DLHÁ , KTORÁ ĽUDÍ PREPRAVOVALA Z JEDNEJ STRANY ,

NA DRUHÚ STRANU . LETISKO KÚSOK OD MESTA BOLO DOMOVOM PRE 

A JEHO KAMARÁTKU , KTORÉ S ĽUĎMI LIETALI PO CELOM SVETE. PREDSTAVTE SI,

ČO SA  OD NICH DOZVEDELO: ŽE VO VEĽKOM MESTE MAJÚ ĽUDIA 

KTORÝ JAZDÍ POD ZEMOU A VOLAJÚ HO METRO. A PRETO SA  AJ SO SVOJIMI

KAMARÁTMI ROZHODLO, ŽE NABUDÚCE PÔJDU NAVŠTÍVIŤ  DO VEĽKÉHO MESTA.

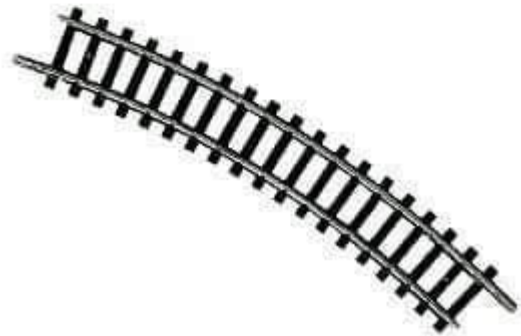
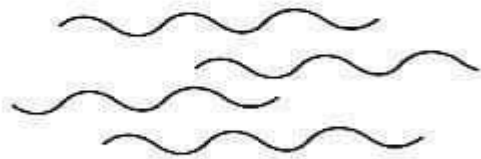
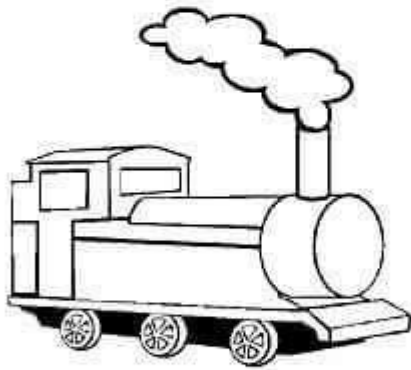

Vyberte v každom rade dopravný prostriedok, ktorý do daného radu nepatrí.

